

PAC II "ALL-IN-ONE" MACHINE SERVICE MANUAL

---

# OPERATION MANUAL



**Model PAC II**



**620 South 1325 West  
Orem, Utah 84058  
PHONE (801) 225-8040  
FAX (801) 226-1509**

---

**IMPORTANT - PLEASE READ THIS CAREFULLY**

The development of a good safety program, that is rigidly enforced, is absolutely imperative when involved in the operation of industrial equipment. Our machinery is well designed and includes extremely important safety features. The part you the user play through proper installation and maintenance procedures is of far greater significance than our designs. Only properly trained individuals following rigidly enforced safety rules, as recommended by A.N.S.I. and O.S.H.A., should be allowed to operate these machines.

---

## **SAFETY PRECAUTIONS**

1. To avoid damage to the machine and injury to the operator, **DO NOT** use liquids of any kind: flammable materials, explosive materials, materials under extreme pressure, pressurized gases, volatile powders, or bulk materials that could fall through holes in grate, or any materials and/or products not listed but which could cause harm to operator.
  2. **Do not touch** the band ribbon soon after sealing due to residual heat that may burn.
  3. **Do not touch** the heater cover plate while machine is on.
  4. **Do not touch** the fan while in operation or use machine without grate in place.
-

## TABLE OF CONTENTS

---

### **Preface**

Unpacking	6-9
Warranty Notice	10
Warranty	11-12
Warranty Exceptions	13
Warnings	14-16

### **PAC II Instructions**

Description and Specifications	17
Installation and Basic Set-Up	18-19
Installation of Film Rack	20
Installation of Plexiglass Hood	21-22
Mounting Film	23
Pin Perforator	24
Product Tray	25
Film Threading Diagram	26
Front Panel	27-29
Sequence of Operation	30-35
Adjusting product grate	35-36

### **Troubleshooting**

No Heat to Band Ribbon	37-42
Weak Seals/Poor Cut Off	43-44
Magnet Won't Hold on Chamber	45-46
No Air Flow	47-48

### **Maintenance**

Band ribbon replacement	50-52
Tape replacement	53
Silicone seal pad replacement	54
Adjust height of hooded chamber	55
Pulse switch adjustment	56
Magnets adjustment	57
Replace transite bars	58
Electrical Panel Diagram	59
Electrical Schematic – PP43ST	60
Parts Nomenclature	61
Replacement Parts List	62-71
Spare Parts List	72

---

**PAC II "ALL-IN-ONE" MACHINE SERVICE MANUAL**

---

**UNPACKING****THOROUGHLY INSPECT EQUIPMENT UPON ARRIVAL.**

If goods are received short or in a damaged condition, it is important that you notify the carrier's driver **before he leaves your company** and **insist** on a notation of the loss or damage across the face of the freight bill. Unless this is done, no claim can be enforced against the transportation company.

If concealed loss or damage is discovered, notify the carrier at once and **insist** on an inspection. This is absolutely necessary! A concealed damage report must be made no later than ten (10) days from the date the shipment was delivered. Unless you do this, the carrier will not consider any claim for loss or damage. The carrier's agent will then make an inspection and grant a concealed damage notation. If you give the transportation company a clear receipt for the goods that have been damaged or lost in transit, you do so at your own risk and expense.

All claims must be filed within six (6) months of delivery date or carrier will not accept them.

Traco Manufacturing is willing to assist in every possible manner to collect claims for loss or damage; however, this does not hold Traco Manufacturing responsible for collection on claims or replacement of material.

## PAC II "ALL-IN-ONE" MACHINE SERVICE MANUAL

---

Your new Model PAC II comes bolted to a pallet and has a tri-walled corrugated box strapped to the pallet to protect it. Cut steel straps and remove corrugated box.



1. If your machine does not arrive in this condition, write on shipping paperwork that outside of box is damaged. **(Concealed damage may have occurred. Before you sign off on delivery paperwork, open box and inspect for damage.)**



2. Remove protective plastic covering from machine.

## PAC II "ALL-IN-ONE" MACHINE SERVICE MANUAL

---

3. Check contents. You should have



- (a) (1) Film Rack
- (b) (1) Film Shaft
- (c) (2) Film Roll Core Chucks
- (d) Plexiglass chamber hood

Remove plastic covering film rack and hood.



4. Remove bolts holding machine to pallet using 10mm wrench.

## PAC II "ALL-IN-ONE" MACHINE SERVICE MANUAL

---



Unwrap plexiglass hood and film rack from the protective bubble wrap.



Film rack includes rack, roll shaft, 8 mounting screws.

---



## **IMPORTANT WARRANTY NOTICES**

### **OPERATING AND MAINTENANCE MANUAL**

The operating and maintenance manual has been carefully prepared to provide the user with all the information needed to properly install, operate, and maintain your Traco Manufacturing equipment.

Please read this manual carefully and refer to it for information on the care and use of your Traco Manufacturing equipment. It is recommended that additional copies be ordered for use by production, maintenance, and supervisory personnel. Although the design of this equipment incorporates safeguards to protect personnel, care should be used in operating, adjusting, and servicing.

Attention is directed to the warranty which accompanies all your Traco Manufacturing equipment. The terms and conditions of this warranty apply only to unmodified units. **Any unauthorized modifications to the equipment automatically voids this warranty.**

**Traco Manufacturing provides a one year warranty on parts, excluding shipping or freight costs for replacement parts. All warranty parts are shipped F.O.B. Orem, Utah.**

---

**PAC II "ALL-IN-ONE" MACHINE SERVICE MANUAL**

---

TRACO MANUFACTURING

**WARRANTY**

Traco Manufacturing, Inc. warrants each new product manufactured to be free from defects in material and workmanship for a period of (1) year from date of shipment by Traco Manufacturing.

This warranty is not transferable with any subsequent resale.

Defective parts under warranty must be returned to Traco Manufacturing freight prepaid. TRACO's sole obligation and purchaser's sole remedy in the event of a warranty dispute shall be, at TRACO's option, to repair or replace the part in question. Labor incurred in removing or installing the defective part is not covered by this warranty. Prior to returning any parts for any reason, contact Traco Manufacturing for a Return Authorization Number. This number must accompany all returns.

This warranty shall not apply if equipment has been tampered with, misused, improperly installed, altered, or has received damage due to abuse, carelessness, accident or failure to follow recommended regular maintenance procedures or has been serviced by someone other than a duly authorized factory representative without the express written consent of Traco Manufacturing, Inc.

This warranty is in lieu of all other warranties, expressed or implied, including but not limited to warranties of merchantability and

**PAC II "ALL-IN-ONE" MACHINE SERVICE MANUAL**

---

fitness for a particular purpose, non-infringement or any other matter.

Traco Manufacturing shall have no liability to any person for direct, indirect, incidental or consequential damages or delay resulting from any defect negligence, or tort and customer hereby waives for itself any and all claims for punitive damages and all claims of negligence of strict liability or both. In no event shall our liability exceed the purchase price of the product that was actually paid.

Traco Manufacturing reserves the right to make changes, additions, or improvements to our products with no obligation to make such changes in any previously shipped product covered by this warranty.

Traco Manufacturing shall not be held liable for any damages arising out of or in connection with the operation of the equipment should customer or its agent fail to maintain equipment in safe operating condition. This warranty shall become unenforceable if and to the extent the customer or its agents remove, disconnect, or otherwise render useless any safety device and/or parts designed or affixed by us or fails to maintain and service equipment in a manner as advised.

**Traco Manufacturing provides a one-year warranty on parts, excluding shipping or freight costs for replacement parts. All warranty parts are shipped F.O.B. Orem, Utah. Service Labor to install part is not covered under warranty!**

**PAC II "ALL-IN-ONE" MACHINE SERVICE MANUAL**

---

**WARRANTY EXCEPTIONS**

The following sealer parts are considered to be consumable and not under warranty:

1. Silicone Sponge
2. Band Ribbon
3. Teflon Tapes
4. Transite Channels/Band Holder

**PAC II "ALL-IN-ONE" MACHINE SERVICE MANUAL**

---

**WARNINGS**

Every effort has been taken to ensure your safety while operating this machine; however, there still remain certain risks. Do not allow this machine to be operated before informing all personnel of the following warnings.

**WARNING.....**

Do not tamper with the electrical wiring. Only use a licensed electrician for maintenance. Always disconnect the electrical power before attempting any maintenance to all electrical and/or moving parts.

**WARNING.....**

In order to prevent injury to personnel and/or machinery **DO NOT INCREASE SETTINGS OR RATINGS ON EITHER ELECTRICAL OR MECHANICAL OVERLOAD SAFETY DEVICES.**

**WARNING.....**

**KEEP HANDS AWAY FROM MOVING CONVEYORS AND ASSEMBLIES.** Conveyor belts that have become worn or frayed are capable of being hazardous. They should be replaced promptly.

**WARNING.....**

**NEVER OPERATE THIS OR ANY MOVING EQUIPMENT WITHOUT ALL COVERS AND GUARDS IN PLACE.** The internal mechanism of most packaging machinery contains numerous shear, pinch, and inrunning nip points, many of which are capable of causing severe injury and/or permanent disfigurement.

**PAC II "ALL-IN-ONE" MACHINE SERVICE MANUAL**

---

**WARNING.....**

To minimize the potential for personnel injury, always be sure that machine operators and others working on the machinery are properly trained in the correct usage of the equipment and properly instructed regarding the safety procedures for operation.

**WARNING.....**

Heat sealing arms and jaws on packaging machinery can become very warm after a period of use. KEEP HANDS AWAY WHILE IN OPERATION AND USE CAUTION IF THE MACHINE HAS BEEN RUNNING RECENTLY.

**WARNING.....**

ANY MODIFICATIONS TO EITHER THE ELECTRICAL CIRCUITRY OR THE MECHANICAL ASSEMBLIES OF THE MACHINERY WILL VOID ANY WARRANTIES ASSOCIATED WITH THIS EQUIPMENT. Such modifications may introduce hazards that would not otherwise be associated with this machinery. Traco Manufacturing will not be responsible for any consequences resulting from such unauthorized modifications.

**WARNING.....**

The use of certain types of plastic films in sealing and/or shrinking equipment may result in the release of HAZARDOUS FUMES due to the degradation of the film at high temperatures. Before using any plastic film in this equipment, the manufacturer or supplier of the film should be contacted for specific information concerning the potential release of hazardous fumes. ADEQUATE VENTILATION MUST BE PROVIDED AT ALL TIMES.

**WARNING.....**

It is important that the machine operator unplug the machine when he/she has finished operating the unit.

## **DESCRIPTION AND SPECIFICATIONS OF MODEL PAC II**

### **DESCRIPTION**

This compact "all-in-one" unit allows the operator to seal and shrink all in one step. The operator simply places the product in the sealing area and lowers the hood to apply the seal pressure necessary to cut the film. Once the seal cycle is complete, the operator releases the handle and the shrink chamber is automatically held shut by the magnet. Once the shrink time is complete, the chamber opens and the operator removes the finished product.

The purpose of a PAC II is for low to medium volume packaging requiring excellent seals and minimal maintenance. It features an impulse mode for sealing of films using "Band Seal Technology."

### **SPECIFICATIONS**

Model:	PAC II
Seal Area:	Length: 18.5"
Width:	12"
Machine Size:	Length: 49"
Width:	26"
Height:	45"
Volts:	110
Phase:	1
Amperage:	20
Weight:	Net 215
	Shipping weight 275



## **INSTALLATION AND BASIC SET-UP OF MACHINE**

### **IMPORTANT**

Read this manual carefully, and make it available to everyone connected with the supervision, maintenance, or production of this machine. Additional copies are available at your request. (Contact your distributor for this information.) Be very careful when operating, adjusting, or servicing this equipment. If in doubt, stop and obtain qualified help before proceeding.

### **INSTALLATION OF PAC II**

Place the PAC II in the desired location with the required electrical power source available. (See power requirements.) Make certain that proper electrical wiring is provided to guard against low voltage. If the voltage is too low, the equipment will not function properly.

Finding the proper location is a most important function of the initial set-up. One must take several factors into consideration:

1. Adequate power source.
2. Relationship to source of product.
3. Relationship to machine.
4. Relationship to any conveyors necessary to remove finished product.
5. Convenience of operator.

The PAC II machine comes complete with power cord and 110 volt plug. Simply plug machine into 110 volt outlet. **Make sure you have no other machine connected to this power source.** If there is any doubt, get qualified assistance to do the initial installation. **Do not take any chances**

Do not attempt to install, adjust, or operate this machine without first reading the contents of this manual. Although the design of the equipment incorporates safeguards to protect operating and maintenance personnel, care should be used in operating, adjusting, and servicing.

## **Installation of film rack**

1.



Remove bubble wrap on film rack as shown.

2.



Hold film rack and slide bearing to the far left side exposing mounting hole for screw. Tighten firmly.



Slide film rack to the far left side to expose mounting holes on right side. Tighten firmly.

## Installation of Plexiglass Hood

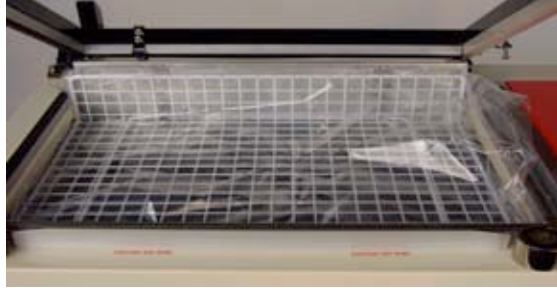

4. Remove plastic bag covering grate and throw away.

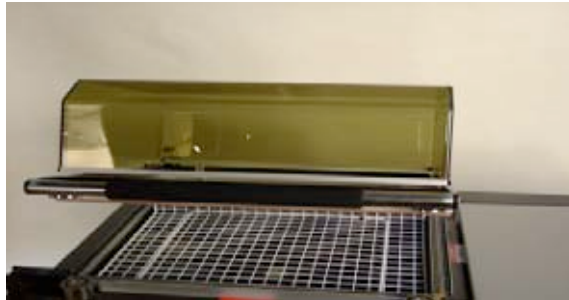

Place plexiglass hood over metal frame and line up metal locking clips over holes in frame.



Locking clips hold hood in place.

Push down firmly and evenly by hand to secure metal clips snap into holes.



## **MOUNTING FILM**

Select the proper width of center-fold film for the item being packaged, allowing for width and height of package. With the package properly positioned within the film in the sealing area, allow sufficient film to overlap the sealing bars so that a seal may readily be made without any possibility of open areas due to insufficient film.



Place film roll on shaft using the two core chucks provided to locate film. Tighten core chucks. The center-fold is to be placed away from the operator, toward the rear of the machine. Position film roll on shaft and tighten film core chuck to hold film roll in position.

Thread film through the two pin perforator wheels provided. Note that the perforator wheel turns freely and is not binding.

Once threaded, separate film top from bottom and insert product tray between. Make sure that the center-fold of film is placed at the rear of the product tray. This allows the operator to insert product between the layers of film on the product tray and to prepare to move product and film into the sealing area. When threading film, make sure the pull more than sufficient film through the rollers, across the product tray, and into the sealing area to ensure sufficient film to begin operation

Place product toward rear of film separator tray. Then move product into seal area. Be sure to leave the bag loose around the product when making the seal. This helps eliminate the seals from blowing out in the shrink chamber. This completes threading and/or mounting film.

## **PIN PERFORATOR**



Located between the film roll and the product tray, the pin perforator creates holes for air to escape as the operator pulls on the film. This allows the air to escape as the package shrinks in the chamber.

The pin perforator is adjustable and must be properly placed in conjunction with the width of the desired package. The positioning should always be re-evaluated when setting the machine for different size product or different size film.

Adjustments to Pin Perforating wheels can be made using the Allen key provided. The Pin Perforator assembly is composed of two components: (1) wheel with pins and (2) grooved wheel without pins on a concentric cam. To adjust pin wheels depth, use Allen key provided and adjust wheel without pins using the concentric cam to turn wheel on shaft to position wheel deeper into pins. Then re-lock Allen screws.

## PRODUCT TRAY



The product tray is an adjustable metal platform used to separate film and to insert product between top and bottom layers of film.



# FILM THREADING DIAGRAM

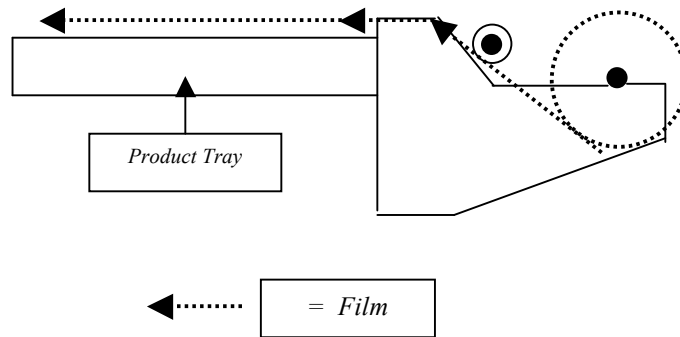

## PAC II Front Control Panel

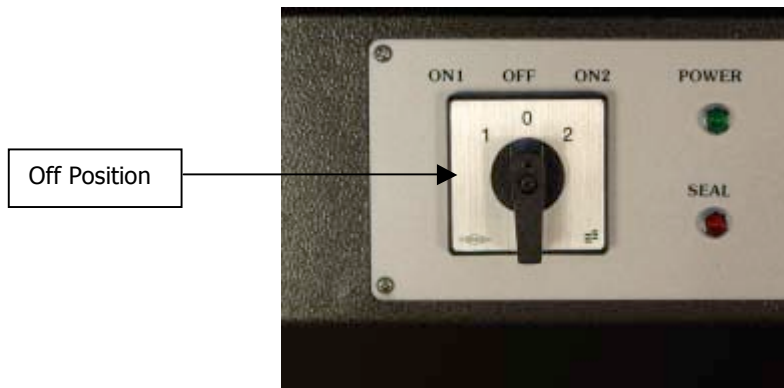

- Main switch is in OFF position. Machine will not operate.

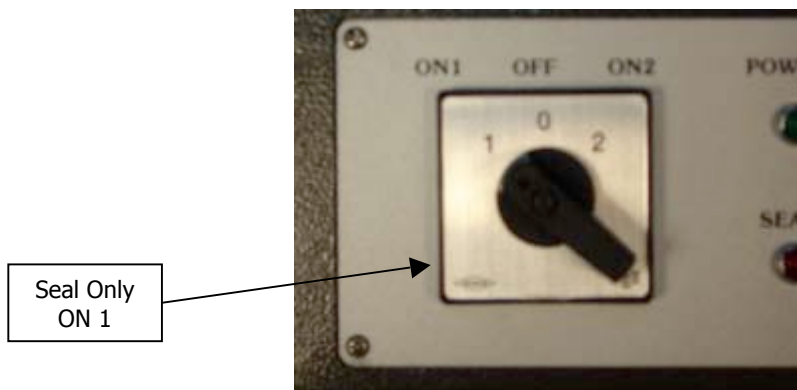

- Main switch in SEAL ONLY position. Machine will only seal product NOT shrink.

**NOTE: When the switch is in the seal only position, the heater in the chamber is off.**

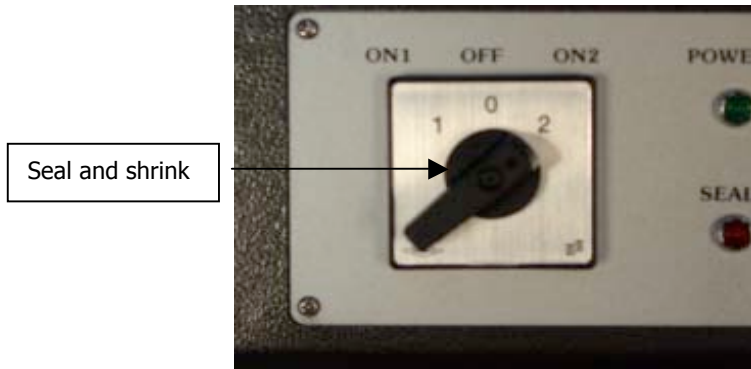

Main switch in SEAL and SHRINK position, both functions are available. Machine will take approximately 10-15 minutes to warm up. You will know it is ready when chamber temperature thermostat goes off.

---

CONTROL PANEL



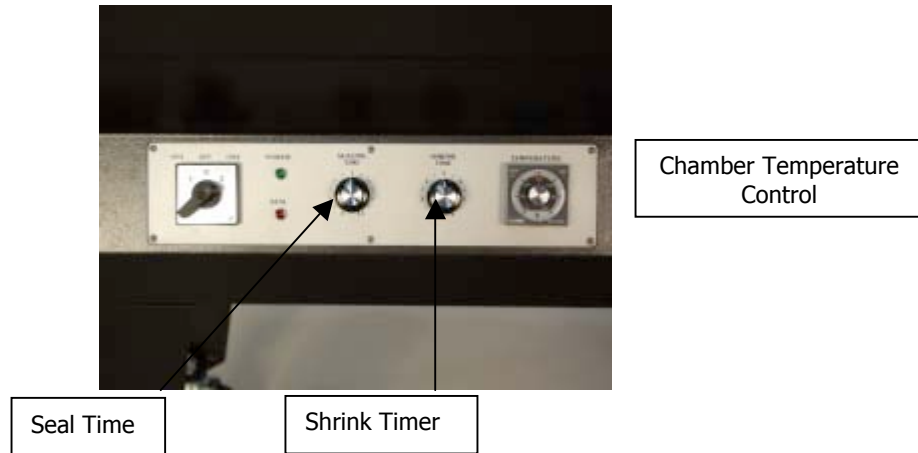

1. **Chamber Temperature:** How hot chamber will become.  
 Recommended settings for PVC Film: 260-280 Degrees  
 Recommended settings for Polyolefin Film: 300 Degrees  
**Note:** These are only a suggested starting point when setting up your machine. These settings will vary depending on the shape of your product and the film thickness used. Remember that thinner gauge films require less heat and less shrink time.
2. **Shrink Time:** Amount of time the air will blow in chamber.  
 Recommended setting for PVC Film: 3-5  
 Recommended setting for Polyolefin Film: 3-5  
**Note:** These are only a suggested starting point when setting up your machine. These settings will vary depending on the shape of your product and the film thickness used. Remember that thinner gauge films require less heat and less shrink time.
3. **Seal Time:** Amount of time band ribbon heats up.  
 Recommended setting for PVC: .6 to 1 seconds  
 Recommended setting for Polyolefin: .5 to .8 seconds  
**Note:** The proper seal time is the shortest time possible to cleanly seal and cut your film. Always start with a shorter seal time where the film will **NOT** cut cleanly, then **increase** dial setting to achieve desired results.

## SEQUENCE OF OPERATION

- A. Product is placed on the film separator tray.
- B. The product tray functions as a means to separate the film, allowing placement of product between upper and lower portions of the film.
- C. Move product into seal area by pushing the product to the left.
- D. Manually pull the hooded chamber down. As the chamber meets the lower switch seal band ribbon, the machine automatically activates the band ribbon. \*

**NOTE:** If too much tension is on the film while the bag is being made, the seals will, more than likely, be weak or will "blow out" in the seal area while the shrinking process is occurring. Make sure to relax the film tension prior to sealing.

- E. The operator simply pulls down the hooded chamber using the handle in front. Once the magnets lock they will apply the proper seal pressure required. Once the seal time is complete, the magnet will release the hood.
- F. At this point, the hooded chamber will stay down automatically during the shrink cycle because the magnet is activated. When the shrink timer is complete, the magnet releases the chamber and it automatically raises allowing the operator to remove the completed product.

## SEQUENCE OF OPERATION

1. After completion of basic setup as described on pages 16-29 plug the sealer's cord into the power source.



- A. With film threaded (see instructions for mounting film), place right hand on package and slide product into the upper left hand corner of the film (i.e., corner formed by folded rear edge of film and previously sealed left edge of film). Push the package toward the rear of the loading tray.



- B. Place right hand under top sheet of film and on front right corner of product. Place left hand on tail of both sheets of film. Now push the package with right hand and pull the film with left hand moving package and film into lower right corner of seal area. Allow from 1/2" to 1" of extra film around package. This will allow some slack film between the package and the sealing bars, reducing film tension.



C. Press hooded chamber handle down. Magnetic lock will hold hooded chamber down and apply necessary pressure to produce seal for duration of seal cycle time set.



D. Shrinking chamber hood will automatically stay down during shrink cycle by use of the magnetic hold-down. Operator is free to get next package ready to seal.



- E. Once shrink cycle time is complete, operator may remove  
Completed product from chamber



**Note:** To increase cycle time and speed of operation, follow this procedure:

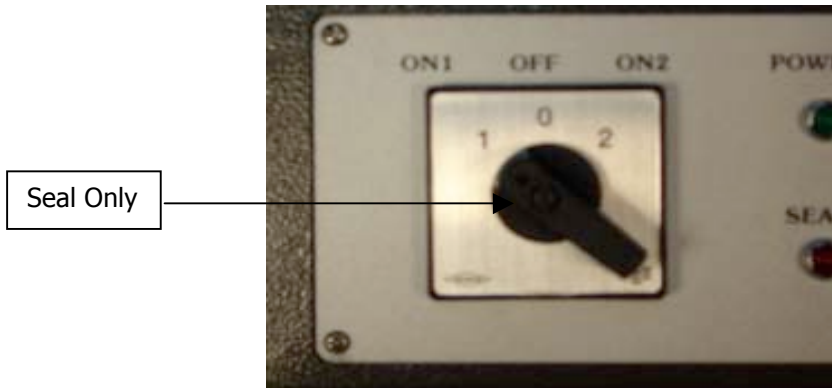

A. Turn Selector switch to SEAL ONLY position.



B. Place product into seal area and seal only.



C. Turn selection switch to seal and shrink.



- D. Place additional product into seal area and now seal and shrink both products at the same time, increasing output of machine.

### **Adjusting Product Grate:**



- A. If product is too tall, film tension is created, producing weak seals. Adjust product tray as follows:



Remove grate to gain access to adjusted studs.



- B. Adjust grill, move screws downward into lower threaded hole.



- C. Product now sits half way below seal pad. This will reduce film tension when sealing and place seal in center of package.

## TROUBLESHOOTING

The following guidelines are provided to aid in determining the source of any operation difficulties which may develop. In performing the tests and checks which follow, carefully inspect for any loose components, broken or loose wires, poor electrical connections, etc., while testing the various switches, controls, relays, transformers, etc. For checking electrical problems, use a voltage meter.

**Note:** While troubleshooting use caution to avoid danger of electrical shock. When power is not required for checking for the presence or value of voltages used, always have it disconnected.

**DISCONNECT ALL POWER BEFORE MAKING ANY REPAIRS.**

**REFER TO ELECTRICAL BOARD LAYOUT AND ELECTRICAL SCHEMATIC FOR LOCATION OF ELECTRICAL COMPONENTS**

### **NO HEAT TO BAND RIBBON**

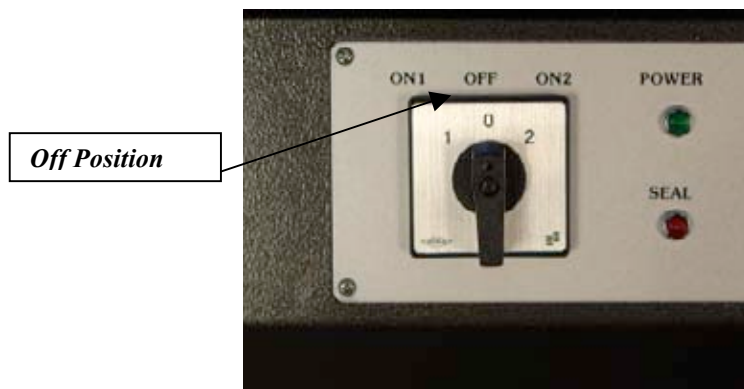

1. Check that the sealer is plugged in and that power is present at the socket. Make sure the power switch is in the **SEAL ONLY** or **SEAL AND SHRINK** position.



2. Make sure seal timer is **not** set on zero (0) on time dial.

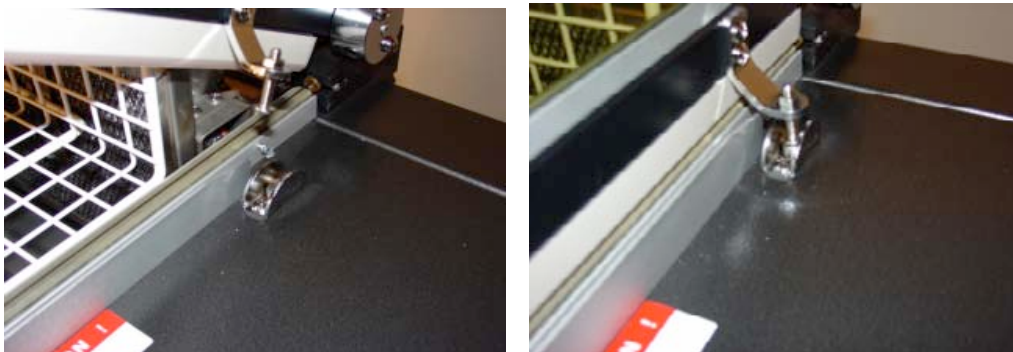

3. **Check pulse switch adjustment.**
  - (a) Make sure switch is being activated when the seal bar is within  $\frac{1}{4}$ " of contact with seal pad.
  - (b) Press switch by hand. If no click is heard, replace switch.

**PP48ST**  
F1-15 Amp  
F2- 20 Amp  
F3-1 Amp  
F4-20 Amp  
F5-1 Amp



4. Check all fuses.



CR1 Contactor

5. Check to see CR1 contactor is ok and the points are not burned or no wire has come loose.



- 6. Check for voltage present at both primary T1 and secondary of transformer T1 as per values shown in the voltage specifications: PP43st (110 volt primary, 42 volt secondary).***



7. Check for broken band ribbon inside or outside the corner Bead.



8. Check for bad connections on each end of band ribbon. Make sure wires are connected to each end of compensator.



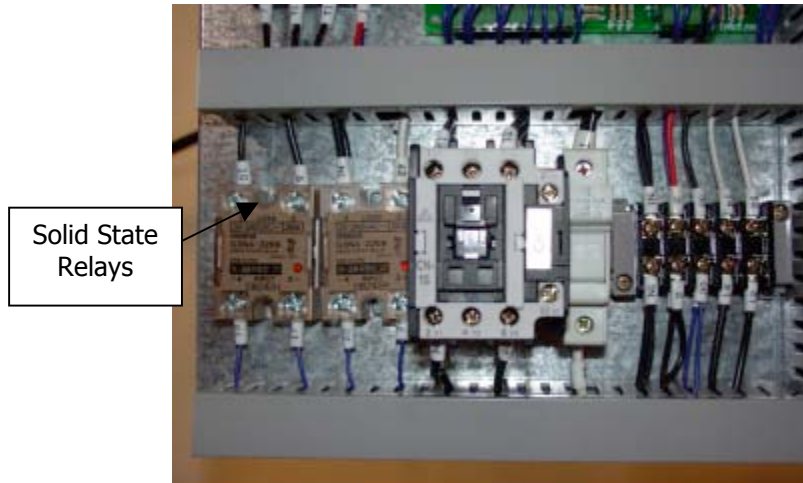

9. Check solid state relay to make sure it is secure in the socket.

## WEAK SEALS AND/OR POOR FILM CUT OFF



1. Improper setting of seal timer. Refer to page 29 for proper adjustment.



2. Improper operating technique. Too much film tension, make sure film is relaxed prior to sealing.

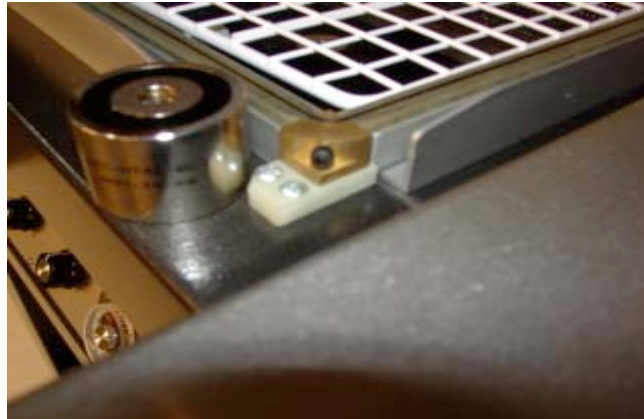

3. Check Band Ribbon to see if cleaning or replacement is necessary. **NOTE: Do not use wire brush to clean Band Ribbon, you will wear off Teflon coating. Use only soft cloth to clean.**

4. Burned teflon tapes 1/2". If teflon tapes become burned or worn, weak seal may occur. See page 53 for Replacement Instructions.

5. Wavy silicone rubber sealing pad. Replace. (See instructions on page 54.)



6. Seal pad pressure incorrect.

### **MAGNETIC HOLD DOWN ON SHRINK CHAMBER**



**NOTE: The dual magnets will hold hooded chamber down during the seal and shrink cycle. Once completed allowing operator to remove package, magnets will release and hood pops open.**

1. Seal head will not stay down – machine operates normally otherwise.

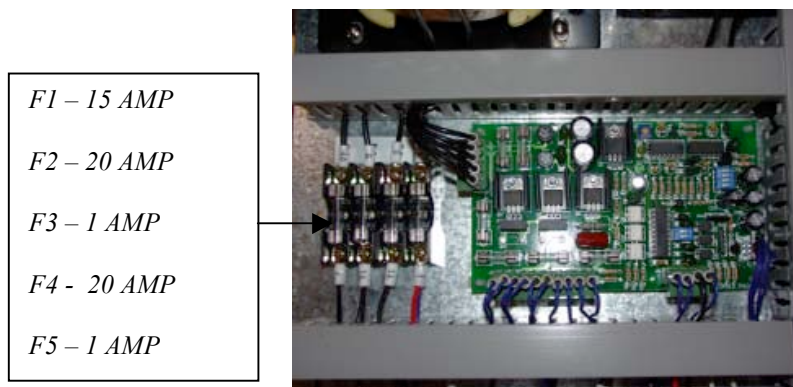

- (a) Check Fuses F1 through F5. Replace if burned.



2. Check shrink (Time) setting. Make sure it is not set at zero.

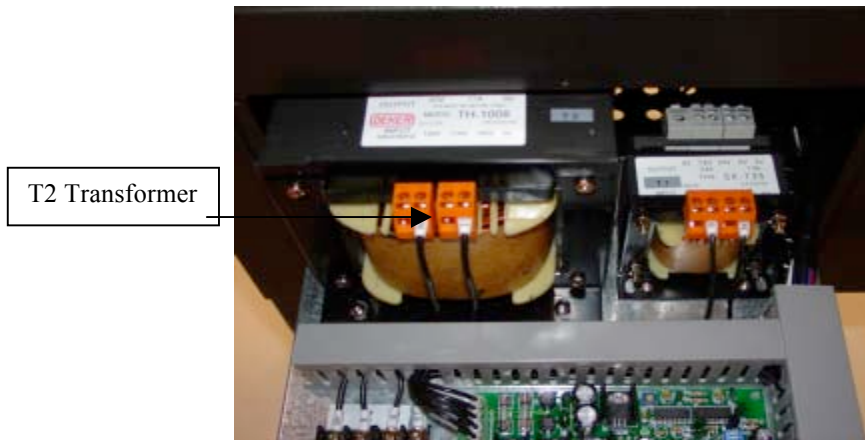

3. Check for 110 volts PP43ST or primary transformer (T2).
4. If voltage is present to primary winding of transformer (T2), check for 24 (nominal) volts output from secondary of transformer.

## **NO AIR FLOW**

**F1 – 15 AMP**

**F2 – 20 AMP**

**F3 – 1 AMP**

**F4 – 20 AMP**

**F5 – 1AMP**

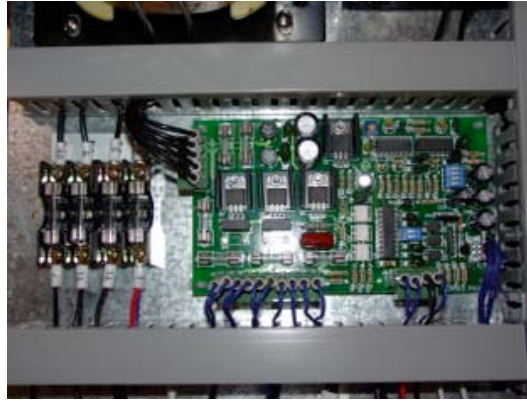

1. Check all fuses.



2. Check blower wheel to see if it is tight on center hub. If loose, tighten bolts holding fan blade to hub.



2. Remove bottom cover from underside on machine.
3. Check Blower motor to make sure no wires are loose.
4. Check capacitor and replace if bad
5. Check blower motor and replace if bad.

## **MAINTENANCE**

- 1. Before working on machine, switch machine off and disconnect power cord from wall outlet.**
- 2. Clean Band Ribbon using soft cloth by wiping Band Ribbon when warm, as it is easier to remove any residue while Band Ribbon is warm.**
- 3. If lower chamber requires cleaning where fan wheel is, we recommend using a vacuum cleaner to remove any particles that may have fallen into the chamber.**
- 4. We recommend you use a glass cleaner to clean the plexiglass hood. Do not use solvents.**



## **BAND RIBBON REPLACEMENT**

The band ribbon is subject to constant wear and will eventually require replacement. To replace band ribbon, proceed as described below.

### **Replacing Band Ribbon**

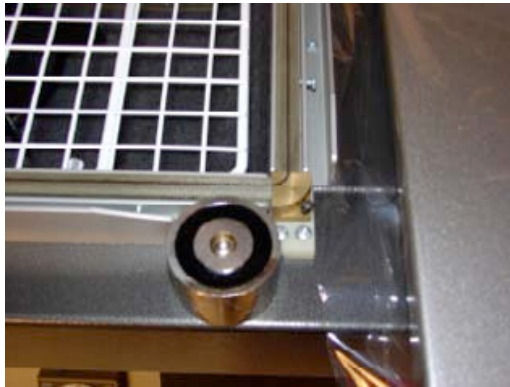

1. Loosen screw holding Band Ribbon in corner.



Band Ribbon screw

2. Loosen screw holding Band Ribbon inside rear compensator assembly.

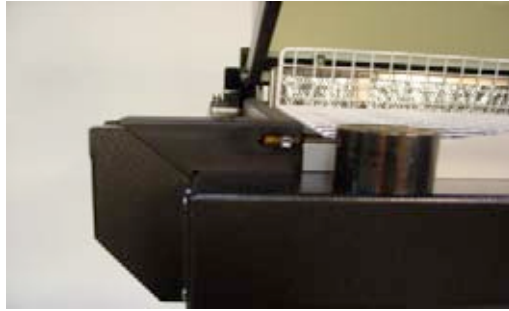

3. Loosen screw holding Band Ribbon in front compensator assembly.



4. Use pre-cut Band Ribbon and place piece of teflon tape ( $\frac{1}{2}$ "L x  $\frac{1}{4}$ "W x 3 mill) around corner of band ribbon to insulate Band Ribbon from brass corner block. Install Band Ribbon on corner first then insert into each end of front and side compensator. **Band Ribbon may be oversized slightly, if so, cut to fit ends.**



5. Compensators are spring loaded. Use screwdriver to push in – flush to transit bars before fastening.

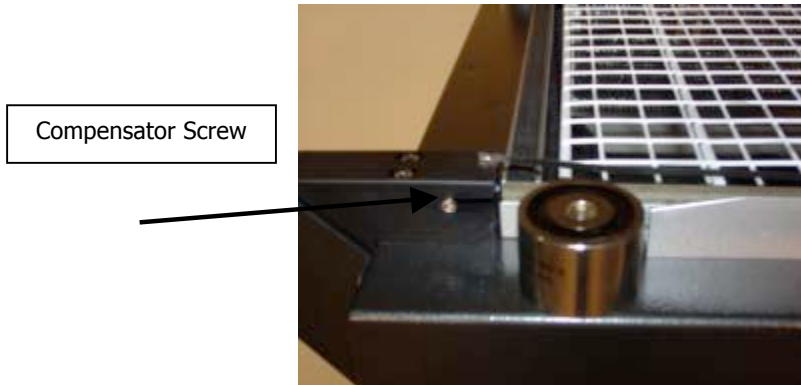

6. Place other end of band ribbon in slot along front seal area. With band ribbon in slot, use screwdriver to move front compensator forward until band ribbon is inside compensator and compensator is resting against the front seal bar.

## **Tape Replacement**

The item most subject to wear on the sealer is the teflon tape used to cover the silicone sponge rubber on the sealing bar. This ½"x 10 mill tape should never be permitted to burn through. To replace tape, proceed as follows:



1. Strip off old tape.
2. Cut off proper length of new teflon, peel off backing, and press new tape into position.
3. Apply ½" x 10 mill Teflon tape over the top of the rubber.

## **SILICONE RUBBER SEALING PAD REPLACEMENT**

Occasionally it will be necessary to replace the silicone rubber sealing pads. This should be done if the following is noted:

- Gaps in the seal
- Weak seals
- Improper film cut-off

**To replace rubber, proceed as follows:**

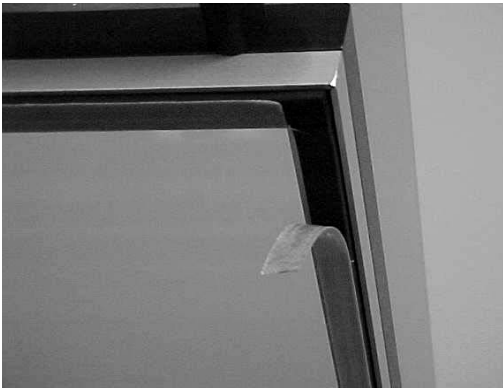

1. Remove teflon tape from seal rubber.
2. Seal pads are designed with a channel for easy replacement. Pull silicone rubber out of the channel.
3. Replace with new silicone rubber. Press rubber back into channel using a double-sided tape to hold rubber in position.
4. Install 1/2" - 10 mill teflon tape on top of rubber.

## **Adjust Hooded Chamber Height**



1. To raise or lower chamber height, adjust hood stop assembly casting by loosening the two mounting bolts. Move assembly casting upward to increase height or downward to decrease chamber height, then tighten bolts.



The bracket hood stop on chamber should be set to compress cushion stop  $\frac{1}{2}$ " deep.

## **Pulse Switch Adjustment**



The sealing cycle should not begin until the chamber hood is within 1/4" or less of the film to be sealed. If the Band Ribbon energizes before the hood is within 1/4" of the film, loosen the lock-nut and turn the screw (located at the rear end of the side seal bar) up slightly (counterclockwise when viewed from above). The correct adjustment has been obtained when the Band Ribbon energizes just as the seal bar comes into contact with Band Ribbon.

## **Adjustment of Magnets for Correct Chamber Pressure**

All magnets have been factory adjusted for equal sealing pressure throughout the length of both the front and side seal bars. However, if an adjustment is required, proceed as follows:

1. Disconnect the sealer's power source.

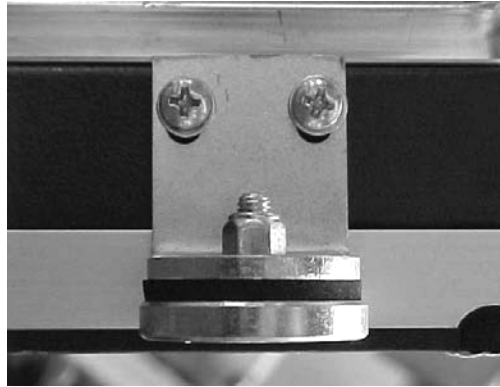
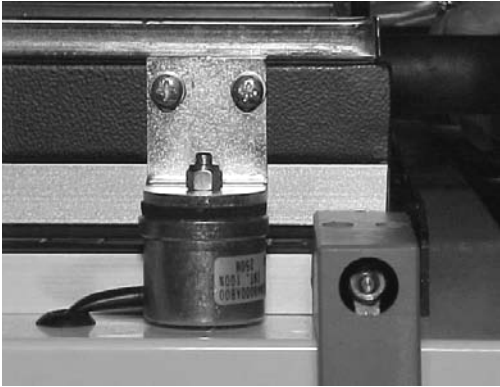

2. Loosen the two upper magnet bolts. Magnets settle to their lowest position in the mounting slots.
3. Lower the chamber handle fully and set the upper mounting bracket to within 1/16" from the lower magnet. Tighten the mounting bolts securely to retain the proper adjustment.



## **Replacing Front and Side Transite Bars**

1. Turn power switch to **OFF** position.

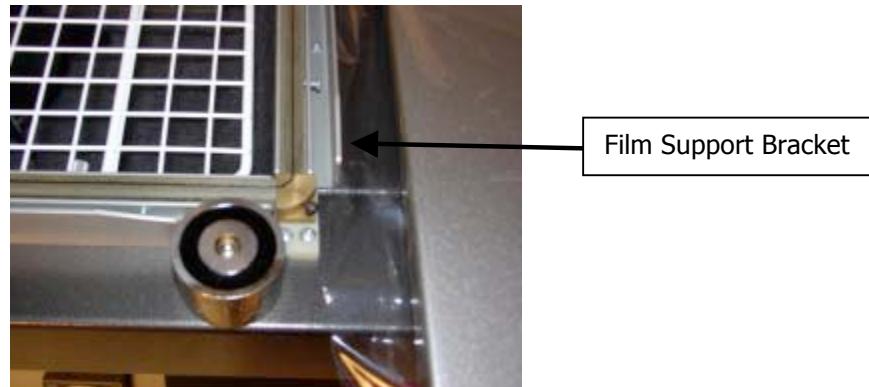

2. See instructions on replacing Band Ribbon on page 49.

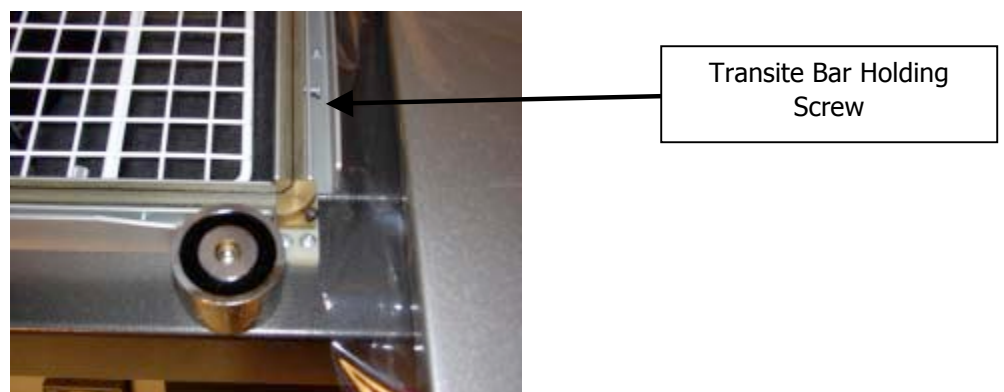

- (a) Remove film support bracket which is mounted next to transite holding channel.
- (b) Remove screws holding transite bars in channel.
- (c) Transite Bar can now be removed from channel. Reinstall new bar.
- (d) See page 50 for instructions on installing new band ribbon.

# ELECTRICAL PANEL DIAGRAM

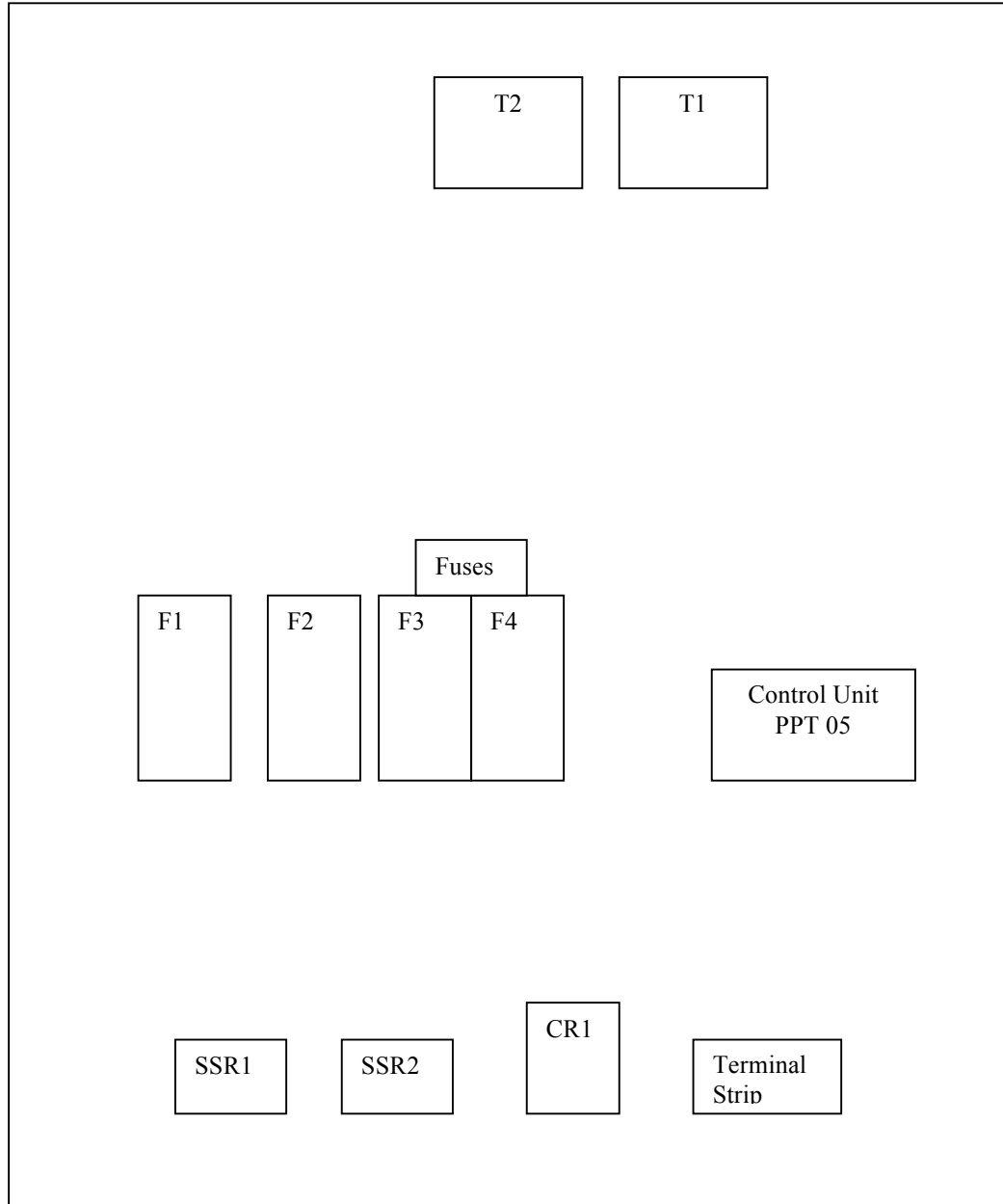

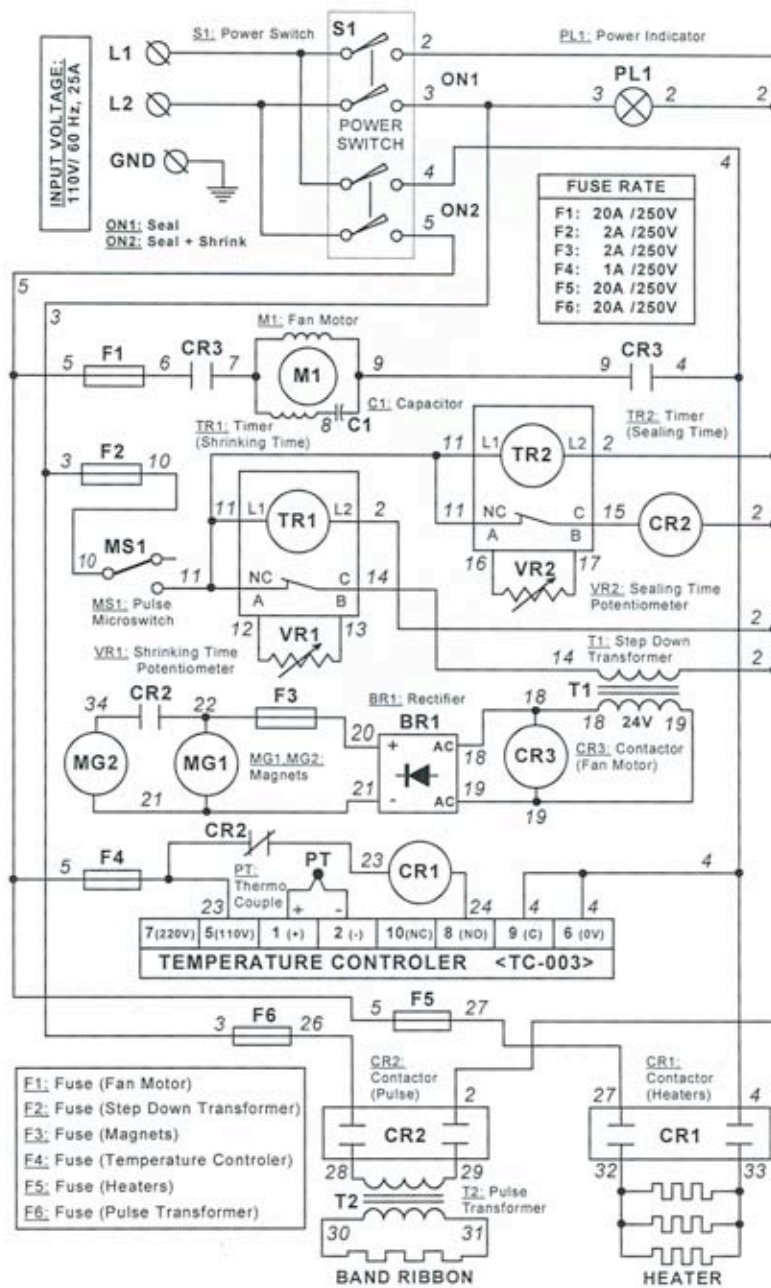

**"ALL-IN-ONE" HOOD MACHINE MODEL: PP48ST (110V)**

## MODEL PAC II

<b>Item</b>	<b>Part#</b>	<b>Qty</b>	<b>Parts List Nomenclature</b>
S1	48-E2060	1	Main Switch
TC1	48-E355-110	1	Temperature Control
CR1	48-E2015	1	Contacto
F1	48-E2040	1	Fuse – 15 AMP
F2	48-E2025	1	Fuse – 20 AMP
F3	48-E2042	1	Fuse – 1 AMP
F4	48-E2025	2	Fuse – 20 Amp
F5	48-E2042	2	Fuse – 1 Amp
T1	48-E2095	1	Pulse Transformer
T2	48-E2085	1	Step Down Transformer
SSR1	48-E2065	1	Solid state relay
SSR2	48-E2065	1	Solid state relay
PPT-05	48-E2075	1	Control unit
MS1	48-E2085	1	Pulse Switch
PL1	48-E2090	1	Power Indicator Light
PL2	48-E2095	1	Sealing Indicator Light
M1	48-M3005	1	Fan Motor
MG1	48-M3010	1	Magnet – Right
MG2	48-M2040	1	Magnet – Left
HT1	48-M2035	2	Heater Bank
C1	48-E2005	1	Capacitor – Blower Motor

## Parts List



<b>Position</b>	<b>Part#</b>	<b>Description</b>	<b>Qty</b>
1.	48-M1085	Legs	4
2.	48-	Main frame	1
3.	48-M3025	Plexiglass hood	1
4.	48-M1090	Loading tray	1
5.	48-M1045	Film rack assembly-complete	1
6.	1519-015	Casters-locking	4
7.	48-M2036	Handle	1
8.	48-M2061	Sponge	1



<b>Position</b>	<b>Part#</b>	<b>Description</b>	<b>Qty</b>
1.	48-E3010	Magnets-Lower	2
2.	48-M3064	Film lift channel-front	1
3.	48-M3020	Grate	1
4.	48-M3063	Film lift channel-side	1

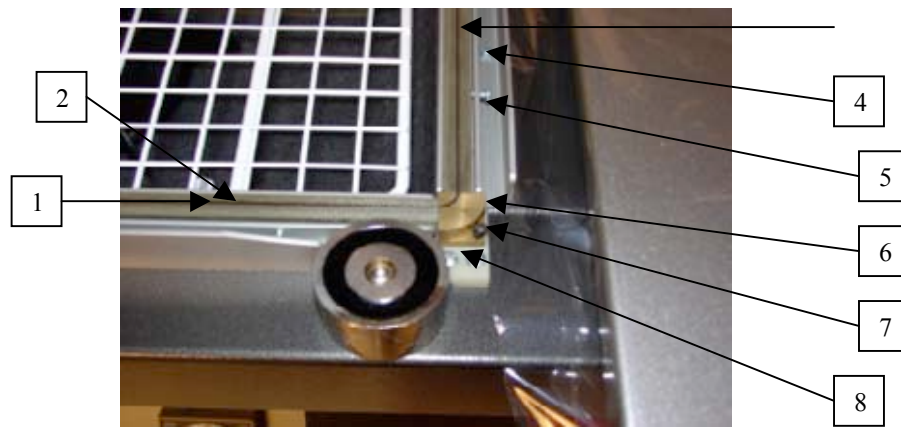

<b><u>Position</u></b>	<b><u>Part#</u></b>	<b><u>Description</u></b>	<b><u>Qty</u></b>
1.	48-M3065	Front transite channel	1
2.	48-M1000	Band ribbon	1
3.	48-M1020	Side-transite channel	1
4.	48-M3052	Screw-film lift channel	4
5.	48-M3054	Screw-transite mounting	4
6.	1519-028	Corner block	1
7.	48-M3056	Allen bolt-band ribbon corner lock screw	1
8.	48-M3042	Screw-corner block mounting screws	1

### **Hooded Chamber**

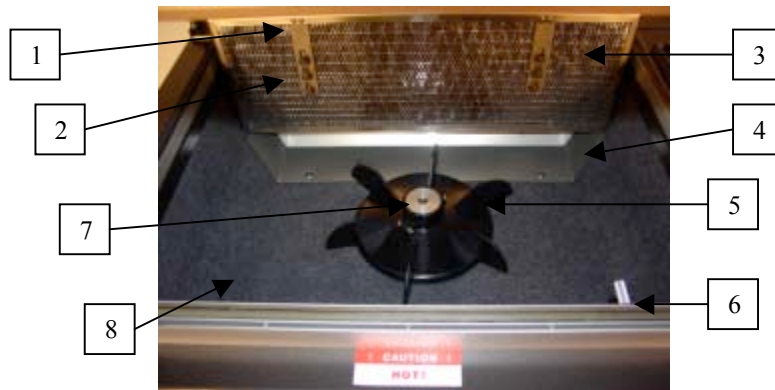

<b><u>Position</u></b>	<b><u>Part#</u></b>	<b><u>Description</u></b>	<b><u>Qty</u></b>
1.	48-M1075	Grate mounting bkt-rear	2
2.	48-M	Metal mesh cover	1
3.	48-M3017	Insulation	1
4.	48-M3018	Metal base plate	1
5.	48-M3016	Fan blade	1
6.	48-M1065	Grate mounting stub-Front	2
7.	48-M3030	Hub fan mounting	1
8.	48-M3016	Felt lining	1



<b><u>Position</u></b>	<b><u>Part#</u></b>	<b><u>Description</u></b>	<b><u>Qty</u></b>
1.	48-E3005	Blower motor	1

### **Rear Panel**



<u>Position</u>	<u>Part#</u>	<u>Description</u>	<u>Qty</u>
1.	48-M3043	Screw-panel	8
2.	48-M2020	Panel	1
3.	48-E2045	Power cord	1

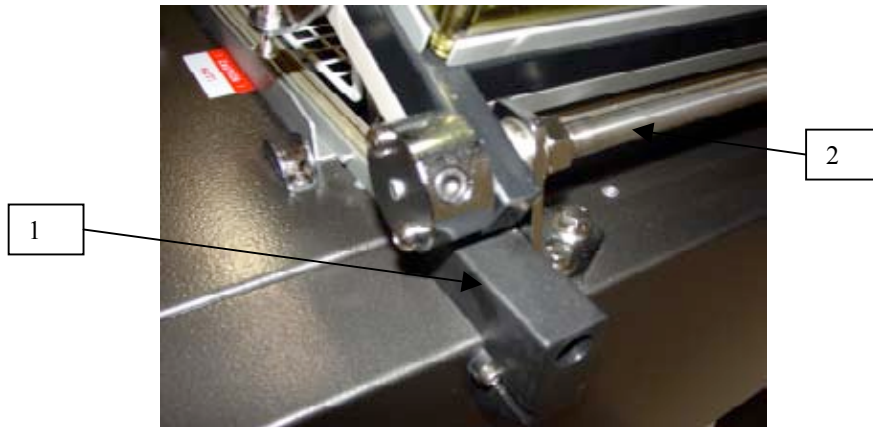

<u>Position</u>	<u>Part#</u>	<u>Description</u>	<u>Qty</u>
1.	1519-177	Compensator assembly-rear	1
2.	48-M3060	Torsion bar	1

### Control Panel



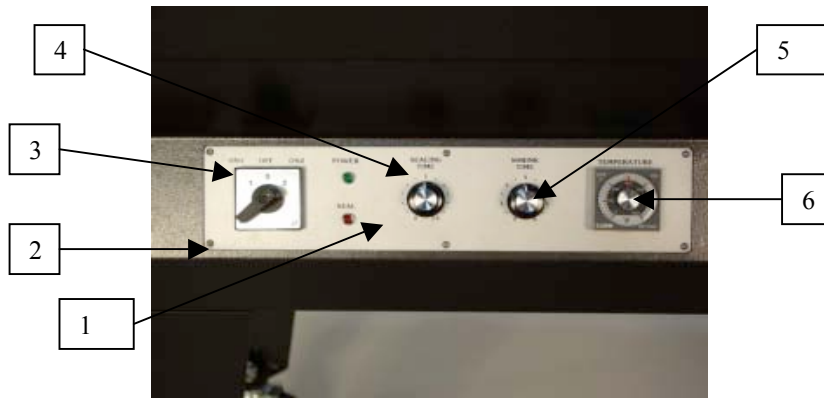

<u>Position</u>	<u>Part#</u>	<u>Description</u>	<u>Qty</u>
1.	48-M1060	Front plate-control panel	1
2.	48-M3043	Screw-face plate mounting screw	6
3.	48-E2060	Switch-main power	1
4.	48-E3046	Seal timer-Potentiometer	1
5.	48-E3046	Shrink timer-Potentiometer	2
6.	48-E355-110	Temperature control	1

### Hole Punch

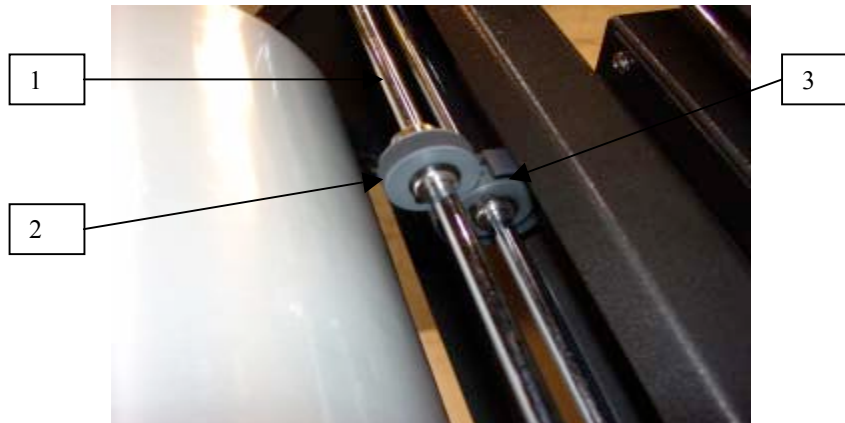

<u>Position</u>	<u>Part#</u>	<u>Description</u>	<u>Qty</u>
1.	48-M1120	Mounting shaft	2
2.	48-M3040	Sponge wheel	2
3.	48-M3041	Pin wheel	2

### Pulse Switch

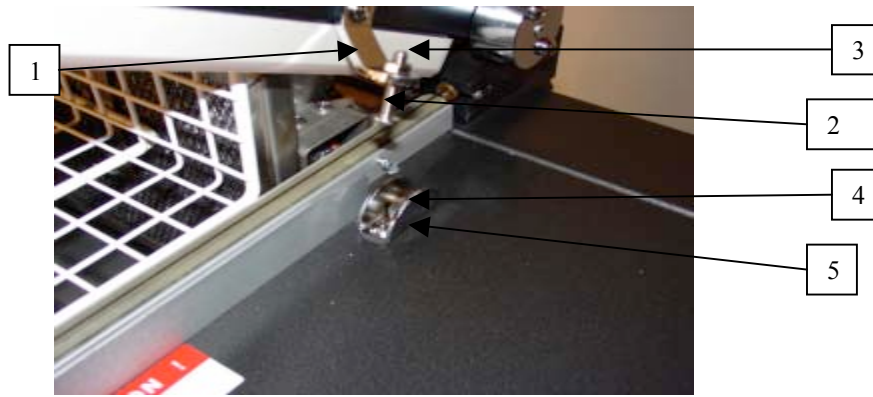

<b>Position</b>	<b>Part#</b>	<b>Description</b>	<b>Qty</b>
1.	48-M3035	Mounting bracket	1
2.	48-M3047	Screw-adjustment pulse switch	1
3.	48-M3048	Nut	1
4.	48-E2085	Pulse switch	1
5.	48-M3061	Switch cover	1

### **Electrical Control Panel**

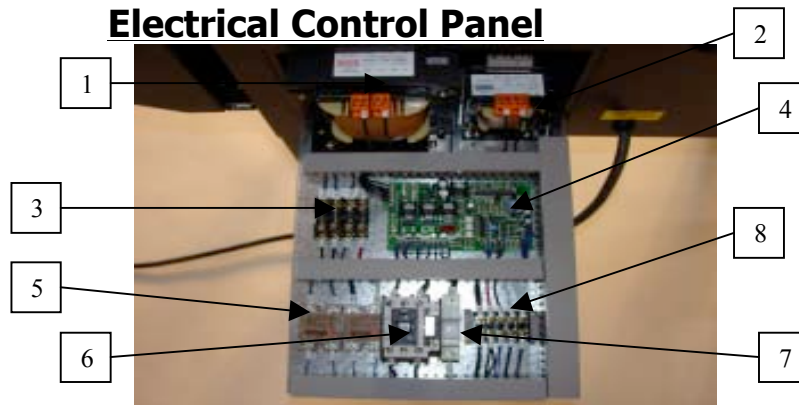

<b>Position</b>	<b>Part#</b>	<b>Description</b>	<b>Qty</b>
1.	48-E2095	Transformer	1
2.	48-E2085	Transformer	1
3.	48-E2019	Fuse	4
4.	48-E2018	Control board	1
5.	48-E2065	Relay-solid state	2
6.	48-E2015	Contactor	1
7.	48-E2017	Fuse	1
8.	48-E2016	Terminal strip	1

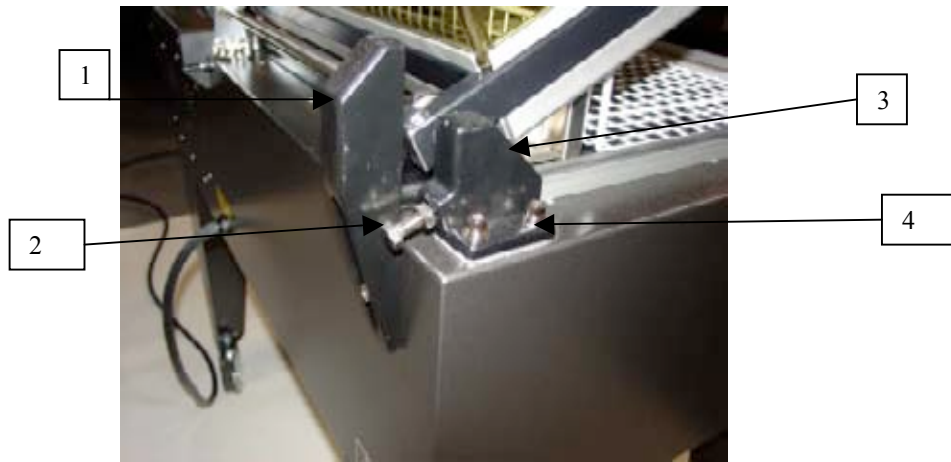

<b>Position</b>	<b>Part#</b>	<b>Description</b>	<b>Qty</b>
1.	48-M1052	Cushion stop	1
2.	48-M1006	Bolt-torsion bar adjustment	1
3.	48-M3066	Castings-torsion bar left side	1
4.	48-M1006	Bolt-Casting mount	2

## PAC II REPLACEMENT PARTS

PP48st	Qty	Description

<b>PP48st</b>	<b>Qty</b>	<b>Description</b>
48-M1000	1	Band Ribbon
48-M1007	2	Bolt-casting mount
48-M3066	1	Bolt-torsion bar adjustment
48-M1005	2	Brackets – Chamber Shaft Mounting Bracket
48-E2005	1	Capacitor – Blower Motor
48-M3066	1	Casting-torsion bar adjustment
48-M1010	1	Chamber Height Adj. Assembly
48-M3064	1	Channel-front film lifter
48-M3065	1	Channel-front/aluminum channel holder
48-M3070	1	Channel-Side/aluminum channel holder
48-M3063	1	Channel-side film lifter
48-M3065	1	Channel – Transite – Front Blade Holder
48-M1020	1	Channel – Transite – Side Blade Holder
1519-176	1	Compensator Assembly – Front
1519-177	1	Compensator Assembly – Side
48-E2015	1	Contacto – CR1
	1	Contacto-solid state
48-E2018	1	Control board
1519-028	1	Corner Block – Brass
48-M3061	1	Cover-pulse switch
48-M1040	1	Cover – Heater Bank
48-M1052	1	Cushion stop assembly
48-M3015	1	Fan blade
48-M3016	1	Felt Padding – Chamber
48-M1045	1	Film Rack
48-M1050	2	Film Roll – Core Chucks
48-M1055	1	Film Separating Bar
48-M1060	1	Front Plate – Control Panel
48-E2040	2	Fuses – F1 and F4 (16 Amp)
48-E2042	2	Fuses (F3, F5) (1 Amp)
48-E2025	2	Fuses – F2 (20 Amp)
48-M3020	1	Grate
48-M1065	2	Grate – Mounting Bracket – Front
48-M3021	2	Grate – Mounting Bracket – Front – Screw
48-M1075	2	Grate – Mounting Bracket – Rear
48-M2036	1	Handle
48-E2035	1	Heater Bank
48-M3025	1	Hood – Plexiglass
48-M3030	1	Hub – Fan Mounting

<b>PP48st</b>	<b>Qty</b>	<b>Description</b>
48-M1085	4	Legs
1519-015	4	Locking Casters
48-M1090	1	Loading Tray
48-E3010	2	Magnet – Seal and shrink-lower
48-M1100	1	Magnet – Upper Mounting Bracket
48-M3004	1	Metal mesh cover
48-M3005	1	Motor – Blower
48-M3035	1	Mounting Bracket – Pulse Switch
48-M3048	1	Nut-lock pulse adjust screw
48-M2020	1	Panel-rear access to electrical
48-M3040	2	Pin Perforator – sponge wheel
48-M3041	2	Pin Perforator – Pin Wheel
48-E2045	1	Power Cord
48-E3046	1	Potentiometer-seal time
48-E3046	1	Potentiometer-shrink time
48-M3043	8	Screw-back panel
48-M3043	6	Screw-face plate
48-M3047	1	Screw-pulse adjustment
48-M3042	2	Screws – Corner Block-Mounting
48-M3045	1	Seal Rubber – Top/Front
48-M3050	1	Seal Rubber – Top/Side
48-M3055	1	Shaft – Roll Holder
48-M1115	1	Shaft – Film Support
48-M1120	2	Shaft – Pin Perforator Support
48-M2061	1	Sponge
48-E2060	1	Switch – Main Power
48-E2085	1	Switch – Pulse
48-M1125	2	Teflon Tape ½" x 10 mill
48-E355-110	1	Temperature Control
48-M3060	1	Torsion Bar
48-M1130	2	Track Bearings – Film Rack
48-E2095	1	Transformer – T1
48-E2085	1	Transformer – T2

**Spare Parts List  
PAC II**

<b>Item #</b>	<b>Part #</b>	<b>Description</b>	<b>Qty.</b>	<b>Price</b>
1	48-E2042	Fuse – F3, F5 - 1 AMP	2	
2	48-E2040	Fuse –F1, - 15 AMP	2	
3	48-E2025	Fuse – F2 - 20 AMP	2	
4	48-1125	½" x 10 mill x 10 yrd. Teflon tape	1	
5	48-M3045	Seal Pad Rubber – Front	1	
6	48M-3050	Seal Pad Rubber – Side	1	
7	48M-1000	Band Ribbon	2	
8	1519-028	Corner Block	1	
9	48M-3065	Channel – Transite – Front	1	
10	48M1020	Channel – Transite – Side	1	
<b>Total Cost</b>				\$145.50